

For reference only. See data sheet for the detailed specifications.

Technical Specification



Frequency Range(GHz)	2.0 – 26.5
Gain(dBi)	4 Typ.
Polarization	Vertical
VSWR	2.0:1 Typ.
	2.5:1 Max.
Connector	SMA-Female
Power Handling (W CW)	50 Max.
Material	Al
Size(mm)	123 x 123 x 84
Net Weight(Kg)	0.40 Around

PATENT ID (China)

ZL202220801477.X

Outline Drawing (Size: mm)

SMA-Female output (P/N: SZ-2002650/P)

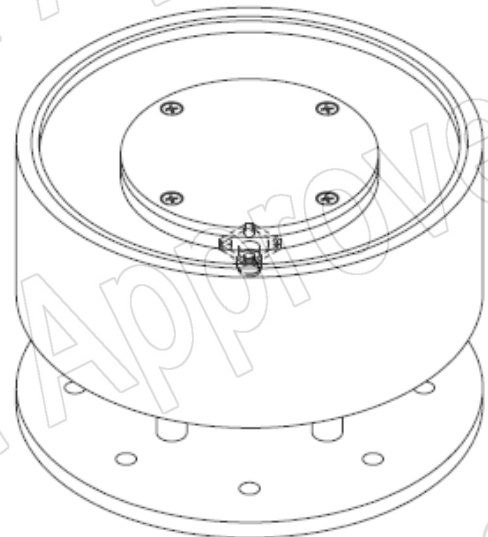
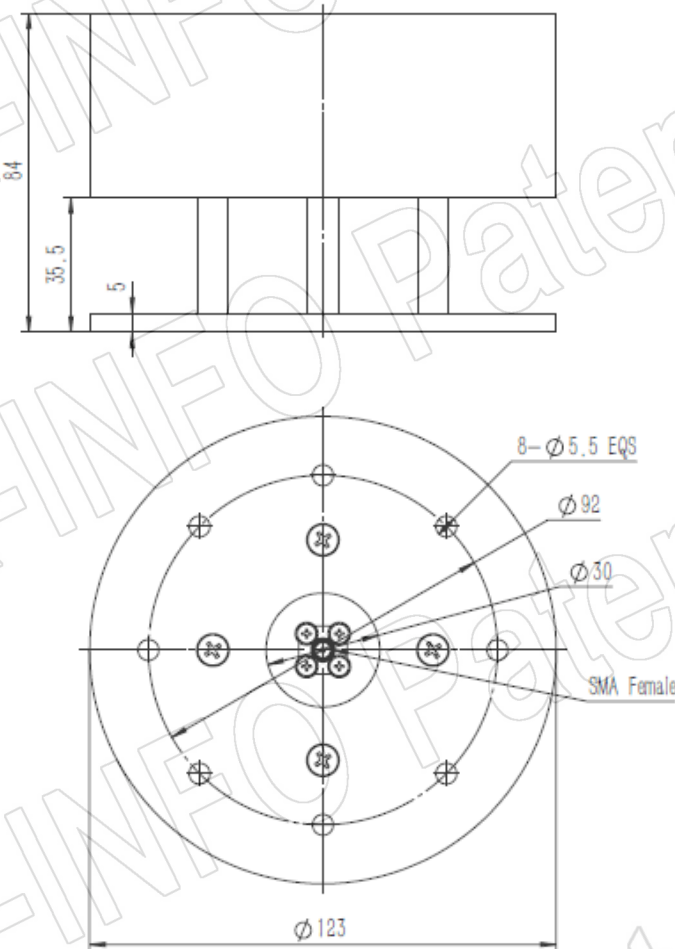

AINFO Inc.

China(Beijing):
China(Chengdu):
USA :

Tel: (+86) 10-6266-7326,
Tel: (+86) 28-8519-2786,
Tel: (+1) 949-639-9688,

(+86) 10-6266-7327
(+86) 28-8519-3044
(+1) 949-639-9608

Fax: (+86) 10-6266-7379
Fax: (+86) 28-8519-3068
Fax: (+1) 949-639-9670

Website: www.ainfoinc.com
Email: sales@ainfoinc.com

SMA-Female output with Round Mounting Bracket (Option, P/N: SZ-2001800/P-MB2)

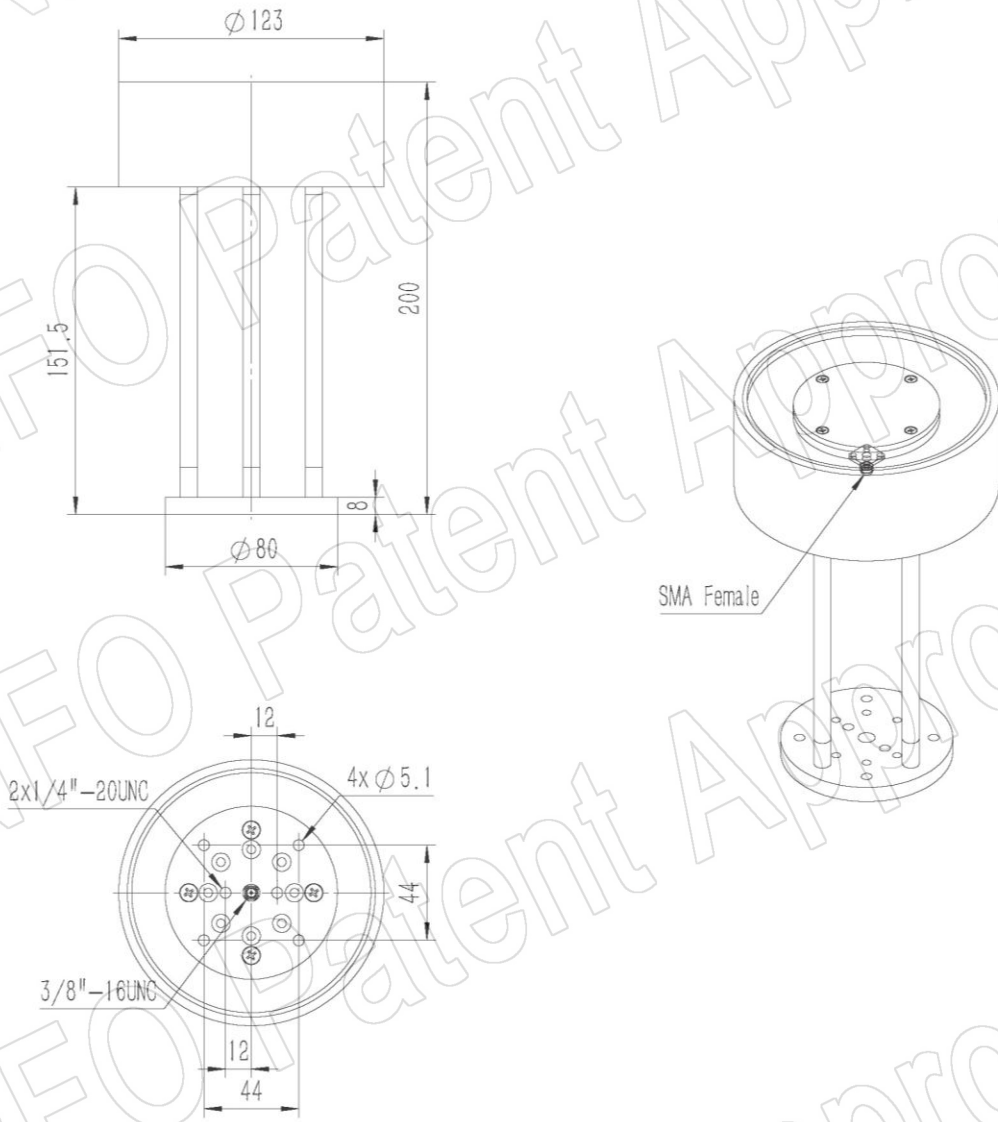

Test Results

1. Gain & Antenna Factor

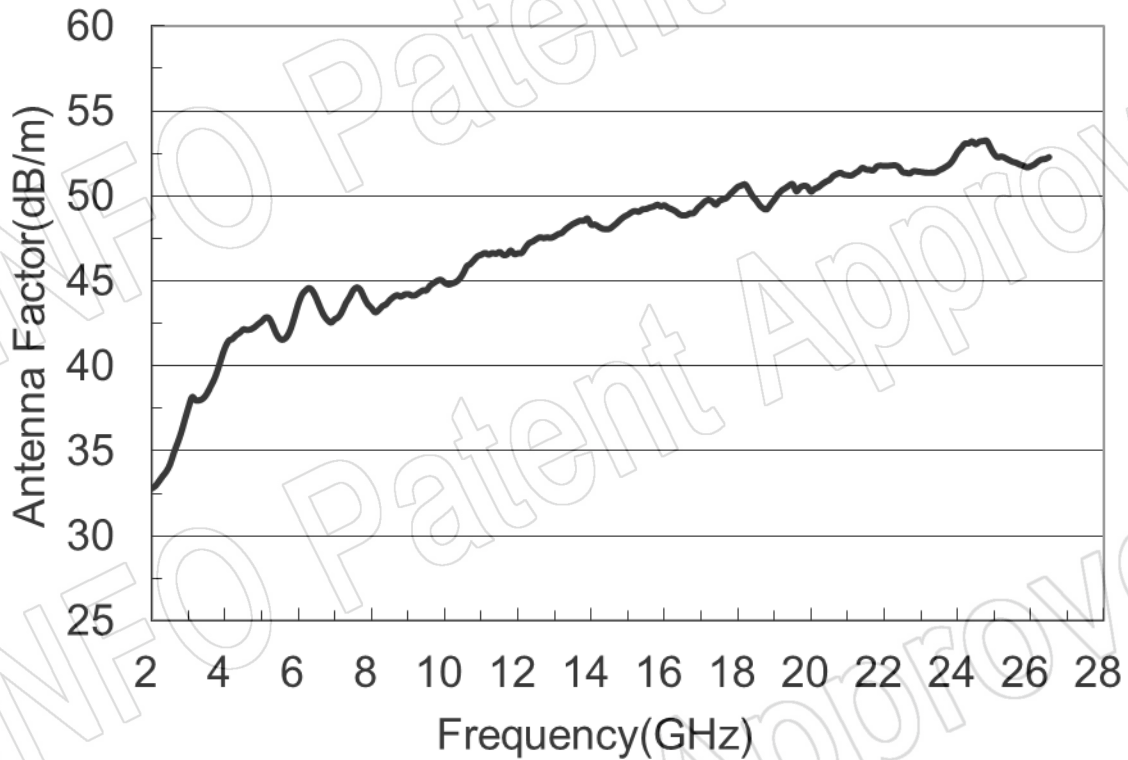
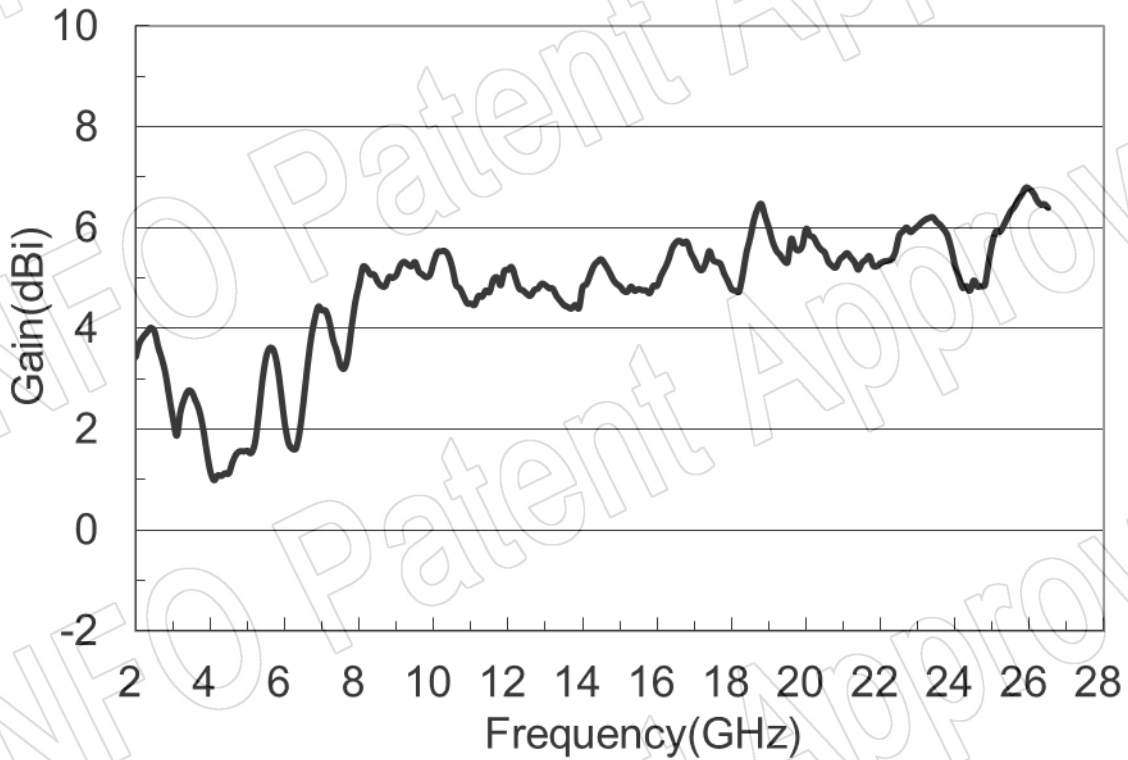

2. VSWR

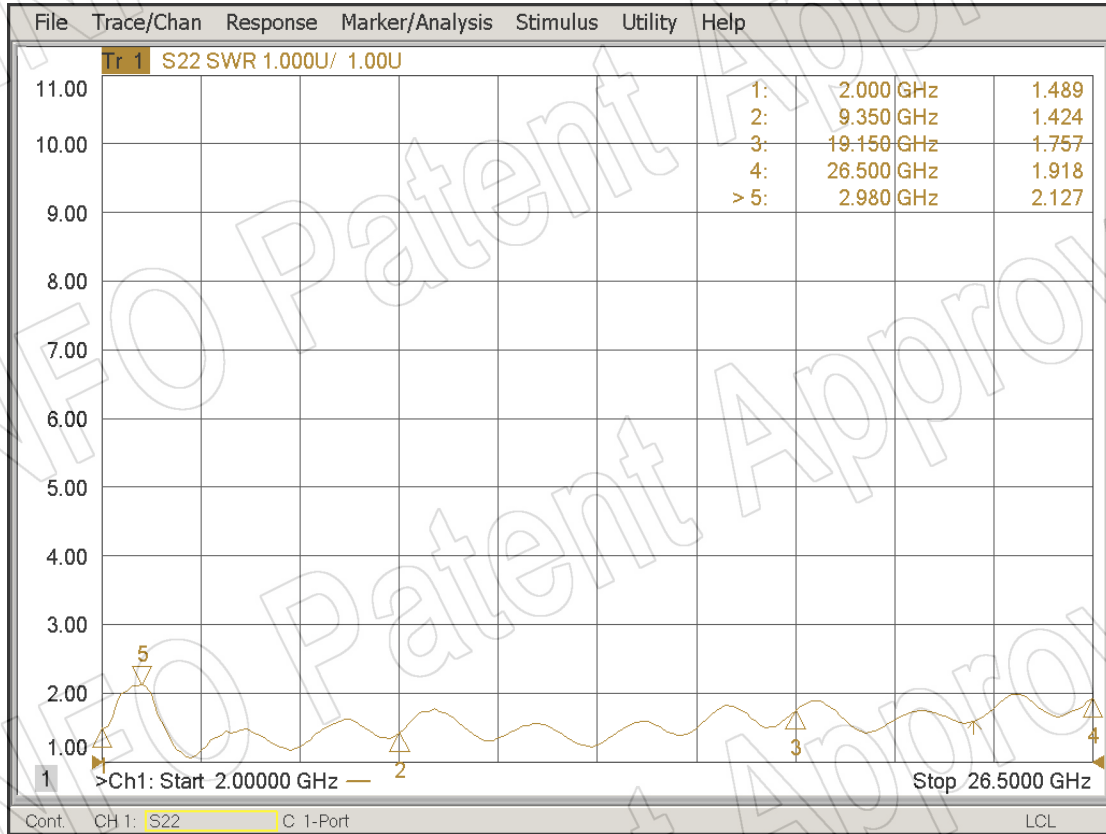

3. Pattern

